

General technical data – Incremental encoders WDGP

Safety instructions

- If a riskless operation can no longer be assured, the unit has to be shut down immediately and be secured against unintended start up.
- In any case of possible hazard of people or possible damage of equipment if the encoder fail, precautions have to be taken to prevent it before start.

Magnetic principle

The WDGP incremental encoders with output circuits Nxx/Mxx work on a non-contact magnetic scanning principle. A diametral magnetised magnet is mounted in the stainless-steel shaft with its backlash-free bearings. If the shaft is rotated, the magnet and the magnetic field rotate with it. This change in the magnetic field is detected and processed by a sensor chip on the PCB opposite. The evaluation enables signals to be generated that are 90° phase-shifted as well as a zero pulse. The downstream electronics conditions these into high-precision signals and amplifies them into industrially usable square-wave pulses in HTL and TTL plus their inverted signals. Our magnetic encoders are finely-tuned measuring systems, combining precision mechanics, efficient sensor technology and high-performance electronics.

Accuracy incremental encoders

Shaft encoders have two defined types of accuracy. In each case the accuracy is given as a % of the period duration, which consists of a pulse and a pause.

The pulse/pause ratio describes the ratio of the pulse length from the period duration. The phase displacement describes the accuracy of two successive edges.

Phase offset:

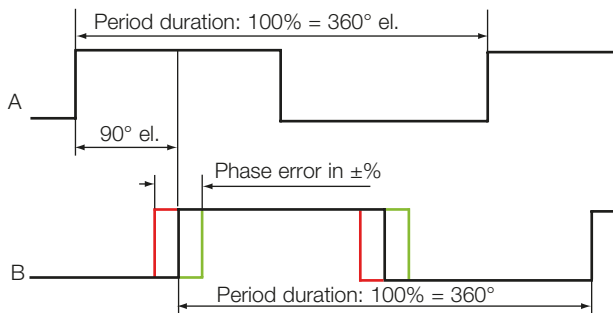

El. phase offset:

90° ± max. phase error 8.5% of a period duration

Pulse-/Pause-ratio

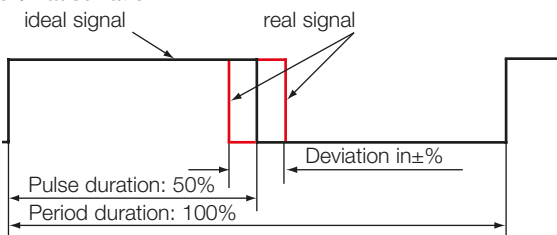

Pulse-/Pause-ratio:

50 % max. ±7 %

Pulse diagram

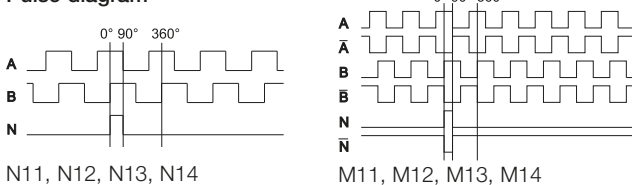

N11, N12, N13, N14

M11, M12, M13, M14

View from shaft end, rotating clockwise

Mechanically rugged

All encoders have double and clearance-free shaft bearings with the maximum possible distance between the bearings, thus obtaining maximum long-term load capacity.

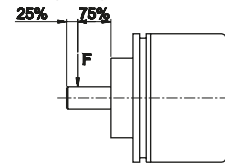

The bearings are treated with a special grease able to withstand extreme temperatures, high speeds and loads, as well as constant operation in reverse. The grease remains stable over a long period of time. The indicated radial-bearing load relates to the point F of the applied force. The useful life of the bearings is stated in the number of revolutions. The life can be converted into hours using the following formula:

$$\text{Life in hours} = \frac{\text{Number of Revolutions}}{(\text{RPM}) \cdot 60}$$

Maximum Operating Speeds

The maximum operating speed is limited by the maximum mechanical operating speed (shaft speed) and by the number of pulses per revolution (PPR). The maximum operating speed is given in the specifications. The maximum speed with relation to the pulse frequency can be expressed as follows:

$$\text{Max. speed of rotation RPM} = \frac{\text{Max. Frequency of encoder in Hz} \times 60}{\text{PPR of encoder}}$$

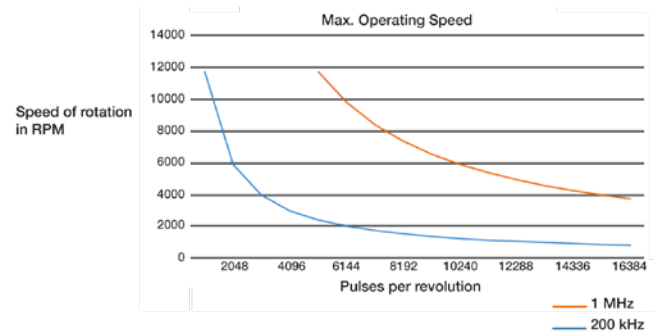

Maximum Output Frequency:

The maximum output frequency is given for the various encoders. For limiting factors such as cable lengths and diameters, please see the section on cable lengths. When designing the electronic evaluation circuitry for maximum frequencies and noise suppression, tolerances should be taken into account in order to provide a safety margin so as to handle maximum output frequencies which may occur in the specific application. The maximum occurring frequency $f_{(\max)}$ can be calculated using the following formula:

$$f \text{ in Hz}_{(\max)} = \frac{(\text{max shaft speed in RPM}) \times (\text{pulses per revolution PPR})}{60}$$

Maximum output frequency $f_{(\max)}$ in relation to cable length and operating voltage at 25 °C and 20 mA load with our Wachendorff cable:

Output circuit	Power supply	HTL: N11/N13/M11/13 f_{aus}	TTL: N12/N14/M12/14 f_{aus}
10 m	4.75 - 32 V	600 kHz	1 MHz
50 m	4.75 - 32 V	600 kHz	1 MHz
100 m	4.75 - 32 V	600 kHz	1 MHz

Reverse polarity and short circuit protection:

All WDGP encoders are protected against reverse polarity of the power supply and short circuit of the outputs. Reversing of the connection cable is completely uncritical in the long term.

	Cable for encoders WDGP
Core	stranded copper wire
Cross-section for signal lines/power lines	0.14 mm ²
Cable cross-section	7 mm ± 0.5
Shield	Tinned braided copper. Stranded filter wire for simple connection
Outer sheath	light-grey PVC
Line resistance for 0.14 mm ² max.:	148 Ohm/km
Operating capacity Core/Core: Core/shield:	140 nF/km approx. 155 nF/km

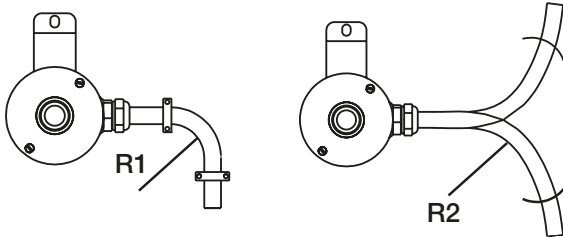

Encoders without low-temperature

Cable Ø	R1	R2	Temperature
≤ 7 mm	31,5 mm	94,5 mm	T > -20 °C (-4 °F)

Cable length:

Using Wachendorff encoder cable a cable run of up to 100 m is possible (150 m for SINUS encoders). However the actual achievable cable length depends on the possible effects of noise interference and should therefore be checked for each individual case. Please refer to the tables regarding the max. output frequency depending on the cable length on page 2.

Typical shielding concepts for encoders with cable outlet

K1, K2, K3: Screen separated at encoder.
Cable screening earthed on customer side
The encoder housing must be earthed separately.

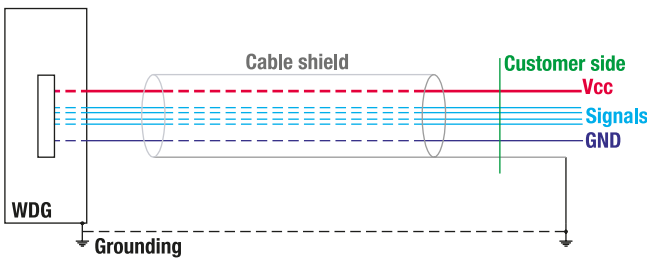

L2/L3, T3: Cable shield connected to encoder housing.
Encoder housing not earthed separately.

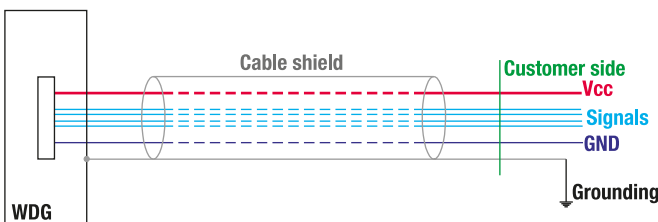

Note:

In order to avoid compensating flows which will damage the ball bearing in an earth loop, earthing on both sides is not recommended.

Protection from Noise Interference

For efficient protection of the entire system we recommend the following measures:

For normal applications it is sufficient to connect the shield of the encoder cable to the earth potential. The entire system, consisting of the encoder and the signal processing equipment should be grounded at one single location by using a low resistance connection (e.g. braided copper).

- In all cases the connecting cables should be shielded and should be locally kept away from power lines and other noise-generating equipment.
- Sources of interference such as motors, solenoid valves, frequency converters etc should always have their noise suppressed at source.
- Encoders should not be powered from the same mains supply as solenoid valves or contactors, as this may cause interference.

In certain applications it may be necessary to install additional protection against interference, depending on the way the system is earthed and on the noise fields present. Such measures would include: capacitive coupling of the screen, the installation of HF- filters in the encoder cable or the installation of transient protection diodes. If these or any other measures are necessary, please contact us.

Environmental Data

Measured mounted and housing grounded.	
ESD (DIN EN 61000-4-2):	8 kV
Burst (DIN EN 61000-4-4):	2 kV
Vibration (IEC 68-2-6):	300m/s ² (10-2000 Hz)
Shock (IEC 68-2-27):	1000m/s ² (6 ms)
Design according to:	DIN VDE 0160



Connection configuration for cable and connector outlets:

On the following pages you will find our standard configuration for cable and connector outlets with regard to the corresponding output circuits. If you would like a special configuration to suit your application, please call our technical support on phone +49 (0) 67 22 / 99 65 131 or send us an e-mail at support-wdgi@wachendorff.de





Connection configuration for cable outlet:

Cabel	K1, L2, L3				Abbreviations for cable colour
	N11, N12	N13, N14	M11, M12	M13, M14	
GND	WH	WH	WH	WH	WH = white
+UB	BN	BN	BN	BN	BN = brown
A	GN	GN	GN	GN	GN = green
B	YE	YE	YE	YE	YE = yellow
N	GY	GY	GY	GY	GY = grey
SET	-	PK	-	PK	PK = pink
A inv.	-	-	RD	RD	RD = red
B inv.	-	-	BK	BK	BK = black
N inv.	-	-	VT	VT	VT = violet
Shield	flex	flex	flex	flex	

Connection configuration for connector outlet:

	SB5/SC5	SB8/SC8	SB12/SC12
Connector pin			
Circuit	N11, N12	M11, M12	M13, M14
GND	3	1	3
+UB	1	2	1
A	4	3	4
B	2	4	6
N	5	5	8
SET	-	-	5
A inv.	-	6	9
B inv.	-	7	7
N inv.	-	8	10
Shield	-	-	-
Connector connected to encoder housing			

Accessories

IP67  5 m	KI-5-67-05-S	KI-8-67-05-S	KI-12-67-05-S
IP67  5 m	KIA-5-67-05-S	KIA-8-67-05-S	KIA-12-67-05-S
IP67  10 m	KI-5-67-10-S	KI-8-67-10-S	KI-12-67-10-S
IP67  10 m	KIA-5-67-10-S	KIA-8-67-10-S	KIA-12-67-10-S

Output circuits / Elektrical Data

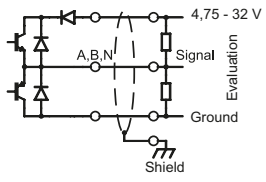
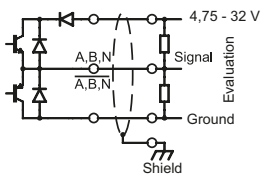
Key	N11 (HTL)	N13 (HTL)	M11 (HTL)	M13 (HTL)
Output circuit				
Power supply	4.75 VDC up to 32 VDC			
Current consumption	typ. 80 mA			
Channels	A, B, N		A, B, N, \bar{A} , \bar{B} , \bar{N}	
Output	push-pull			
Load	max. 40 mA / channel			
Signal level	at 20 mA $H > U_B - 2.5 \text{ VDC}$ $L < 0.5 \text{ VDC}$			
Pulse frequency	max. 600 kHz			
Circuit protection	inverse-polarity and short-circuit protection			
SET zero pulse	no	yes	no	yes

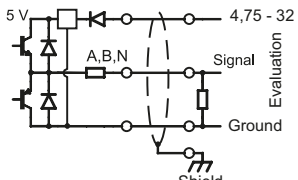
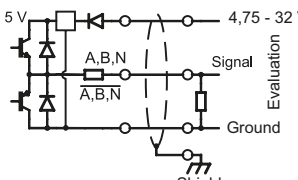
Key	N12 (TTL)	N14 (TTL)	M12 (TTL)	M14 (TTL)
Output circuit				
Power supply	4.75 VDC up to 32 VDC			
Current consumption	typ. 80 mA			
Channels	A, B, N		A, B, N, \bar{A} , \bar{B} , \bar{N}	
Output	push-pull			
Load	max. 40 mA / channel			
Signal level	at 20 mA $H > 2.5 \text{ VDC}$ $L < 0.5 \text{ VDC}$			
Pulse frequency	max. 1 MHz			
Circuit protection	inverse-polarity and short-circuit protection			
SET zero pulse	no	yes	no	yes